

Darlington

2SB1587

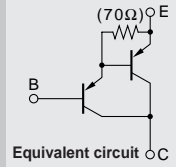

Silicon PNP Epitaxial Planar Transistor (Complement to type 2SD2438)

Application : Audio, Series Regulator and General Purpose

■Absolute maximum ratings (Ta=25°C)

Symbol	Ratings	Unit
V _{CB0}	-160	V
V _{CE0}	-150	V
V _{EBO}	-5	V
I _c	-8	A
I _B	-1	A
P _c	75(T _c =25°C)	W
T _j	150	°C
T _{stg}	-55 to +150	°C

■Electrical Characteristics (Ta=25°C)

Symbol	Conditions	Ratings	Unit
I _{CB0}	V _{CB} =-160V	-100max	μA
I _{EBO}	V _{EB} =-5V	-100max	μA
V(BR)CEO	I _c =-30mA	-150min	V
h _{FE}	V _{CE} =-4V, I _c =-6A	5000min*	
V _{CE(sat)}	I _c =-6A, I _B =-6mA	-2.5max	V
V _{BE(sat)}	I _c =-6A, I _B =-6mA	-3.0max	V
f _T	V _{CE} =-12V, I _E =1A	65typ	MHZ
COB	V _{CB} =-10V, f=1MHZ	160typ	pF

*h_{FE} Rank ○(5000to12000), P(6500to20000), Y(15000to30000)

■Typical Switching Characteristics (Common Emitter)

V _{CC} (V)	R _L (Ω)	I _c (A)	V _{BB1} (V)	V _{BB2} (V)	I _{B1} (mA)	I _{B2} (mA)	t _{on} (μs)	t _{stg} (μs)	t _f (μs)
-60	10	-6	-10	5	-6	6	0.7typ	3.6typ	0.9typ

External Dimensions FM100(TO3PF)

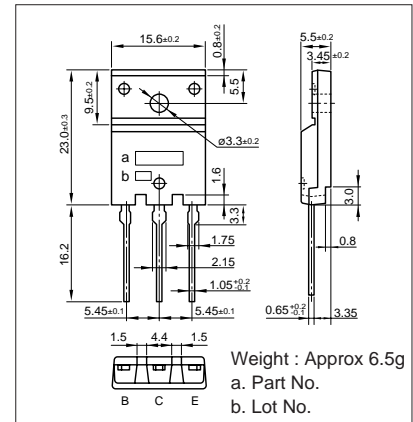

I_c-V_{CE} Characteristics (Typical)

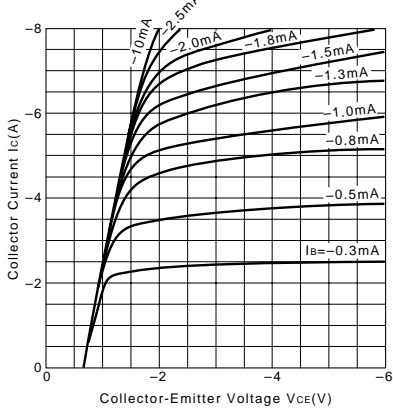

V_{CE(sat)}-I_B Characteristics (Typical)

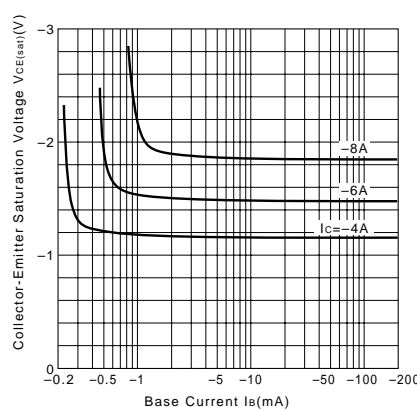

I_c-V_{BE} Temperature Characteristics (Typical)

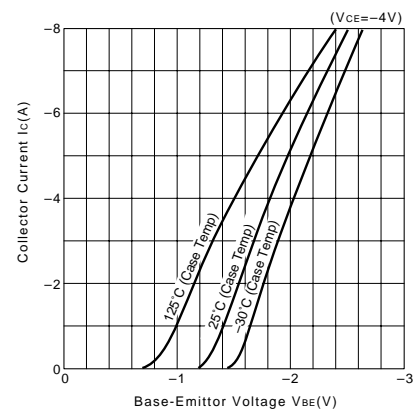

h_{FE}-I_c Characteristics (Typical)

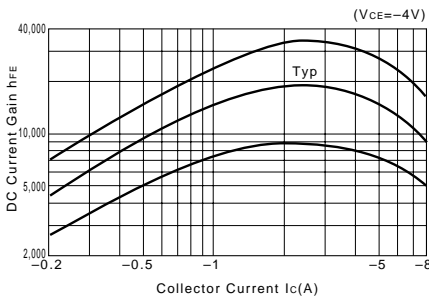

h_{FE}-I_c Temperature Characteristics (Typical)

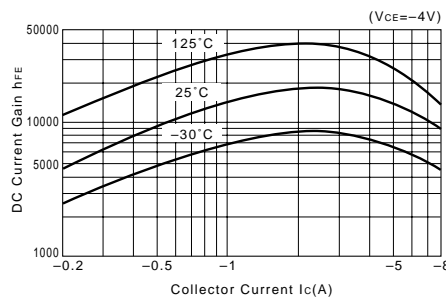

θ_{j-a}-t Characteristics

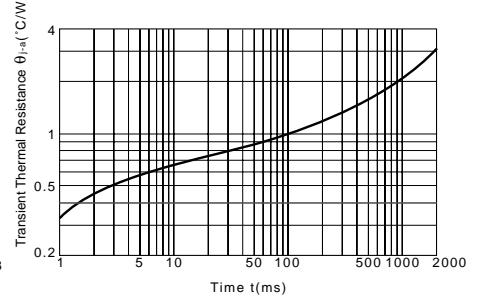

f_T-I_E Characteristics (Typical)

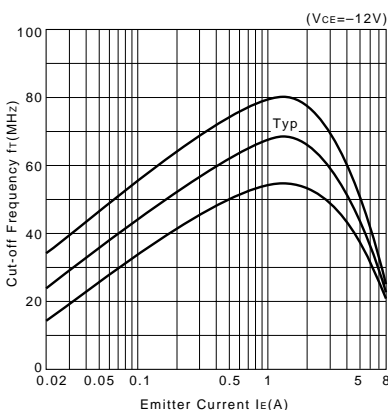

Safe Operating Area (Single Pulse)

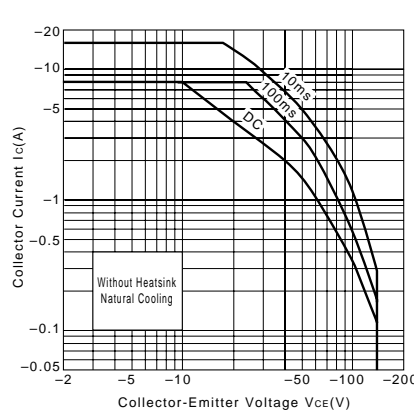

P_c-T_a Derating

